

EUROTECH 7KG VENTED DRYER

ED-FVD7KGWH

INSTRUCTION MANUAL

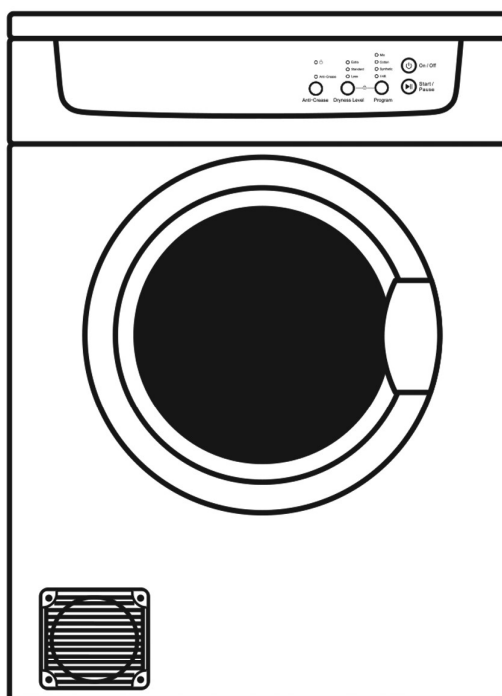

PLEASE READ THIS MANUAL CAREFULLY BEFORE
USING YOUR PRODUCT AND KEEP IT FOR FUTURE
REFERENCE.

CONTENTS

SAFETY INSTRUCTIONS

■ Safety Instructions	2
-----------------------------	---

INSTALLATION

■ Product Description	7
■ Installation	7

OPERATIONS

■ Quick Start	9
■ Before Each Drying	10
■ Control Panel	11
■ Drying Programmes Table	12

MAINTENANCE

■ Cleaning And Care	13
■ Trouble Shooting	14
■ Technical Specifications	15

SAFETY INSTRUCTIONS

■ Safety Instructions

- The appliance is not intended for use by persons (including children) with reduced physical, sensory or mental capabilities, or lack of experience and knowledge, unless they have been given supervision or instruction concerning use of the appliance by a person responsible for their safety.
- Children should be supervised to ensure that they do not play with the appliance.
- If the power cable is damaged, it must be replaced by the manufacturer, its service agent or similarly qualified persons in order to avoid a hazard.
- In EN standard countries, this appliance can be used by children from 8 years and above and persons with reduced physical, sensory or mental capabilities or lack of experience and knowledge if they have been given supervision or instruction concerning use of the appliance in a safe way and understand the hazards involved.
- Children shall not play with the appliance, cleaning and user maintenance shall not be made by children without supervision.
- The tumble dryer is not to be used if industrial chemicals have been used for cleaning.
- The lint trap has to be cleaned frequently.
- Lint must not be allowed to accumulate around the tumble dryer.
- Do not dry unwashed items in the tumble dryer.
- Items that have been soiled with substance such as cooking oil, acetone, alcohol, petrol, kerosene, spot removers, turpentine, waxes and wax removers should be washed in hot water with an extra amount of detergent before being dried in the tumble dryer.

SAFETY INSTRUCTIONS

- Items such as foam rubber (latex form), shower caps, waterproof textiles, rubber backed articles and clothes or pillows fitted with foam rubber pads should not be dried in the tumble dryer.
- Fabric softeners, or similar products, should be used as specified by the fabric softener instructions.

⚠ Warning!

Never stop a tumble dryer before the end of the drying cycle unless all items are quickly removed and spread out so that the heat is dissipated.

- The exhaust air must not be discharged into a flue which is used for exhausting fumes from appliance burning gas or other fuels.
- The appliance must not be install behind a lockable door a sliding door or a door with a hinge on the opposite side , to that of the tumble dryer. In such a way that a full opening of the tumble dryer door is restricted.
- Oil-affected items can ignite spontaneously, especially when exposed to heat sources such as in a tumble dryer. The items become warm, causing an oxidation reaction in the oil.Oxidation creates heat. If the heat cannot escape, the items can become hot enough to catch fire. Piling, stacking or storing oil-affected items can prevent heat from escaping and so create a fire hazard.
- The appliance should not be overturned during normal use or maintenance.
- Remove all objects from pockets such as lighters and matches.

SAFETY INSTRUCTIONS

- For appliances with ventilation openings in the base, that a carpet must not obstruct the openings.
- Children of less than 3 years should be kept away unless continuously supervised.
- Plug must be accessible after installation.
- Warning: The appliance must not be supplied through an external switching device, such as a timer, or connected to a circuit that is regularly switched on and off by a utility.
- Remove all packages before using the appliance. Otherwise, serious damage may result.

Correct Disposal of this product:



This marking indicates that this product should not be disposed with other household wastes throughout the EU. To prevent possible harm to the environment or human health from uncontrolled waste disposal, recycle it responsibly to promote the sustainable reuse of material resources. To return your used device, please use the return and collection systems or contact the retailer where the product was purchased. They can take this product for environmental safe recycling.

Model	Rated capacity
ED-FVD7KGWH	7.0kg

SAFETY INSTRUCTIONS

- **Power supply and grounding**

The dryer employs alternative current with the rated voltage and frequency. When the voltage fluctuates between 6% of rated voltage, the dryer can work normally.

A special power socket with a capacity $\geq 10A$ for the dryer had better be set beside the dryer for convenience and safety. The method of connection of the socket is as the figure below.

To be safe, please make improvements as soon as possible according to the rules and suggestions mentioned above.

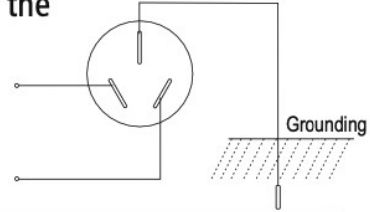

⚠ Warning!

The socket and the grounding wire must be installed by an electrician to prevent incorrect installation or use of the socket and to guarantee the safety of use of electricity. No connection of the grounding wire and the neutral wire, otherwise the cabinet will be charged, which is likely to cause the danger of electric shock.

- **Precautions**

Install or store where it will not be exposed to temperatures below freezing or exposed to water or weather, which could cause permanent damage and invalidate the warranty.



Keep area around the exhaust opening and adjacent surrounding areas free from the accumulation of lint, dust and dirt. An obstructed port might reduce the airflow.

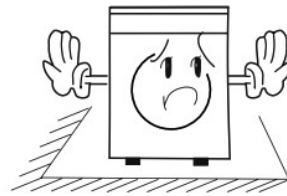

Thoroughly spin the laundry in washing machine. High spin speed can reduce the drying time and save energy consumption.



Make sure combustible sprayer will not be close to dryer when it is working, and once the gas leaks, do not touch plug or start/pause on it.

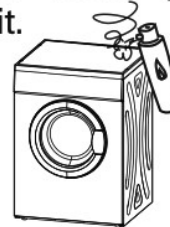

SAFETY INSTRUCTIONS

Do not wash or dry articles that have been cleaned in, washed in, soaked in or spotted with combustible or explosive substances (such as wax, oil, paint, gasoline, degreasers, dry-cleaning solvents, kerosene, etc.).

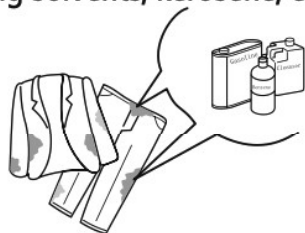

Never attempt to operate this appliance if it is damaged, malfunctioning, partially disassembled, or has missing or broken parts, including a damaged cord or plug.



Do not allow children on or in the appliance. Close supervision of children is necessary when the appliance is used near children.

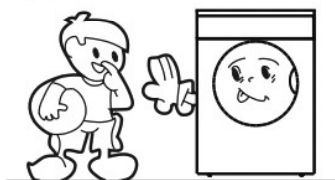

Please do not use the machine when your foot or hand with water.

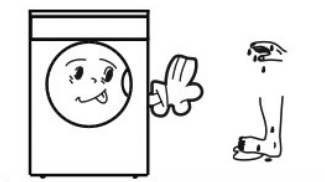

Do not store plastic, paper or clothing that may burn or melt on top of the dryer during operation.



The exhaust air must not be discharged into a flue which is used for exhausting fumes from appliance burning gas or other fuels.

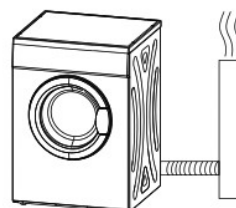

Do not dry articles containing rubber, plastic or similar materials such as padded bras, tennis shoes, galoshes, bath mats, rugs, bibs, baby pants, raincoat plastic bags or pillows that may melt or burn. Some rubber materials, when heated, can under certain circumstances produce fire by spontaneous combustion.



The door can be opened only after the programme of the drying machine is completed. Do not open the door before the programme finished to avoid the human skin from being scalded by hot steam or over heated drying machine.

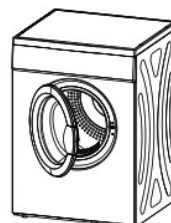

INSTALLATION

■ Product Description

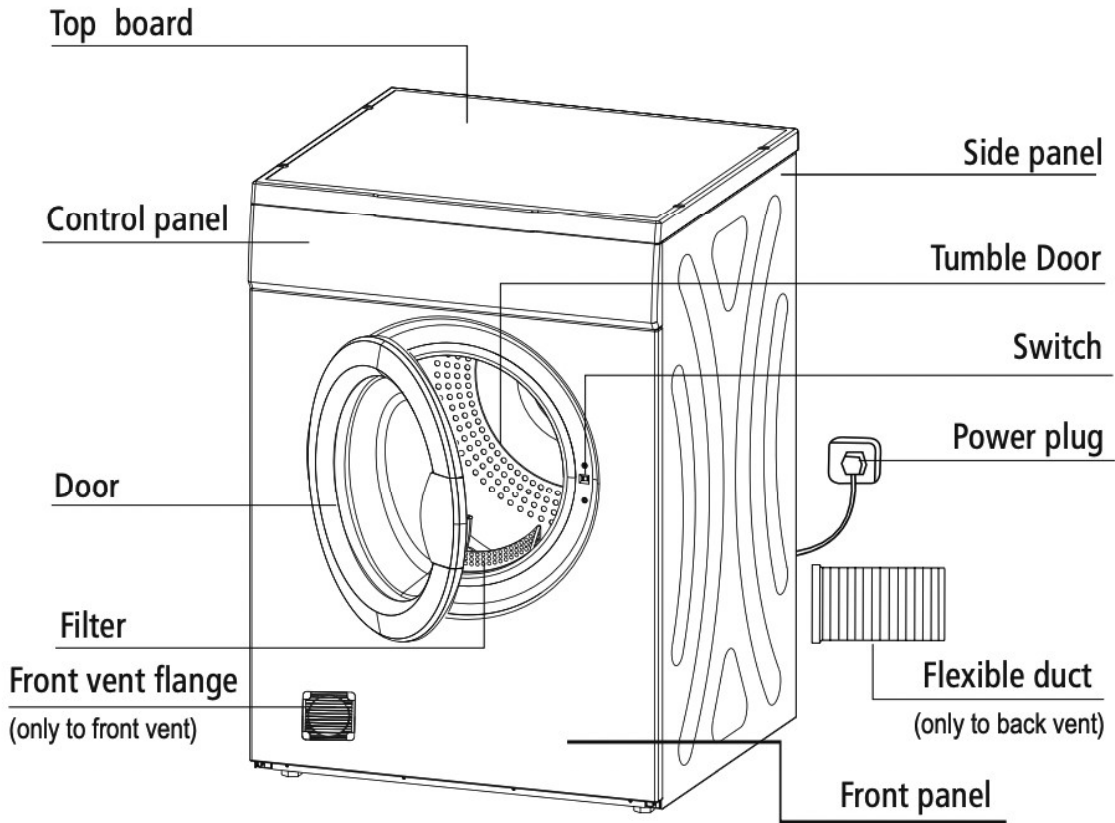

■ Installation

- Dryer should be placed in a ventilated area with not less than 10cm distance from the wall. It is suggested there are no obstacles within 1.5m in front of dryer and keep ventilated.

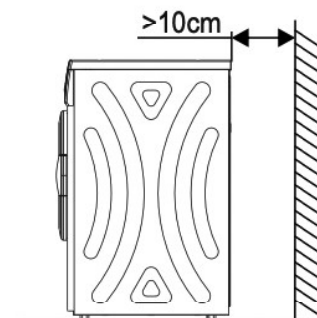

OPERATIONS

■ Quick Start

📌 Note!

Before using, please make sure it's installed properly.

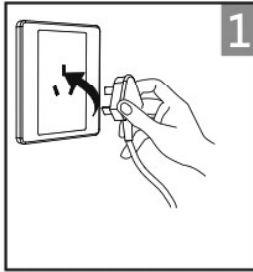

plug in

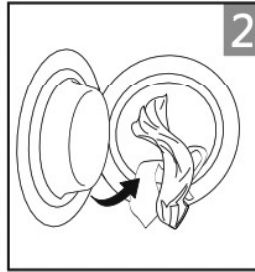

load

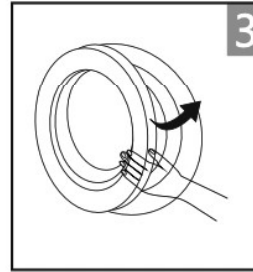

close door

Drying



on



select program



select function
or default



start

After Drying

Buzzer beep or "0:00" on display.

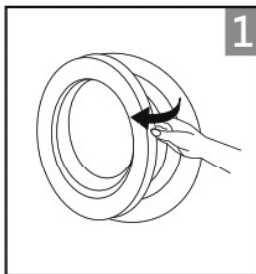

open the door and
take out laundry

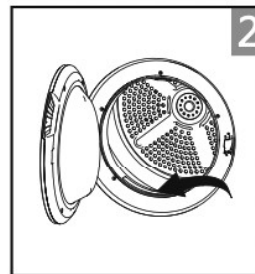

clean the filter

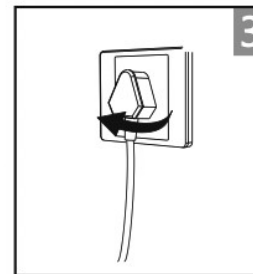

power off

📌 Note!











- If the socket with a switch is used, please press the switch to turn off the power directly.

OPERATIONS

■ Before Each Drying

1. Before drying, thoroughly spin the laundry in washing machine. High spin speed can reduce the drying time and save energy consumption.
2. For uniform drying result, sort the laundry according to fabric type and drying programme.
3. Before drying, please close zips, hooks and eyelets, button up, tie fabric belts, etc.
4. Do not over dry the clothes, because over dried clothes can easily get creases.
5. Do not dry the articles containing rubber or similar elastic materials.
6. The door can be opened only after the programme of the drying machine is human skin from being scalded by hot steam or over heated drying machine.
7. Clean the lint filter and empty container after each use to avoid extension of drying time and energy consumption.
8. Do not dry these clothes after dry-clean process.













The reference weight of dry clothes (each)

 Mixed-fabric clothes (about 800g)	 Jacket (about 800g cotton)	 Jeans (about 800g)	 Towel quilt (about 900g cotton)
 Single bedsheet (about 600g cotton)	 Work clothes (about 1120g)	 Sleepwear (about 200g)	 Long sleeve shirt (about 300g cotton)
 Short sleeve shirt (about 180g cotton)	 Short pants (about 70g cotton)	 Socks (about 50g mixed-weave)	

Note!

- Never overload.
- Not for textile with dropping water. The dryer could be damaged, even fire.
- Not suitable for silk or woolen textiles.

Please pay attention to use the drying machine if the materials of your clothes can not be dried by it or contain the symbols as follows:

 Dry	 Normal	 Not tumble dry normal	 Do not dry
 Line dry / hang to dry	 Drip dry	 Dry flat	 In the shade
 Dry clean	 Do not dry clean	 Dry clean normal cycle with any solvent	 Dry clean normal cycle petroleum solvent only

OPERATIONS

■ Control Panel

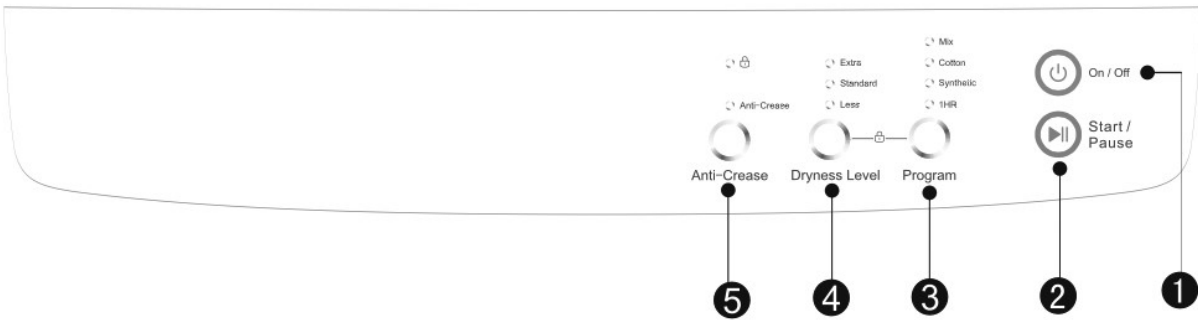

1 On/Off

Product is switched on or off.

4 Dryness Level

(Extra/Standard/Less)

2 Start/Pause

Press the button to start or pause the drying cycle.

5 Anti-Crease

At the end of the drying cycle, the anti-crease phase time is 30 minutes (default) or 120 minutes (selected).

3 Programmes

Different Dryer cycle can be selected according to the user's needs to make the clothes have more effective drying results.

📌 Note!

- Press the **【Program】** button to select the desired programme.
- Press the **【Dryness Level】** button to select the desired programme.
- Press the **【Anti-Crease】** button to start Anti-Crease function.
- Press the **【Start/Pause】** button.
- Press the **【Delay】** button to booking the drying process.
- If users need child lock function, pressing the **【Program】** and **【Dryness Level】** buttons simultaneously for over 3 seconds to start child lock function. Press the two button 3sec. also to be released the function. The "Child Lock" will lock all buttons except **【On/Off】**. Cut off the power supply, the kid's protection is to be released.
- The buzzer will prompt from the dryer when finishing the cycle. Press the **【On/Off】** button and pull out the power cable.
- Clean the filter, cabinet and inner tube.
- Clean the filter when the "Filter" light is flashing, after the dryer stop.

MAINTENANCES

■ Drying Programmes Table

Clothing Type	Approximate amount of remaining humidity	Capacity (KG)	Programs	Dryness Level	Note
Cotton	80%-90%	7	Cotton	Extra	Please according to the Type and Capacity of the clothing to select the most suitable Program and Dryness Level.
	60%-70%	7 / 3.5	Cotton	Standard	
		7	Cotton	Less	
Mix	70%	7 / 3.5	Mix	Extra	
	60%	7 / 3.5	Mix	Standard	
Synthetic	50%	3.5	Synthetic	Extra	
	40%	3.5	Synthetic	Standard	
Cotton	—	1	1Hr	—	

Note!

- If Anti-Crease option is selected, the anti-crease process will enlarge to 2 hours, otherwise it keeps 30min without this option.
- The inside temperature and humidity will affect drying time.
- “Cotton + Extra” is for AS/NZS energy program.

MAINTENANCES

■ Cleaning And Care

Filter clean

- Clean the lint filter after each use.
Remove by pulling straight up.
- Cleaning filter
Use wiping cloth or your fingers.
- Install filter
If the filter is cleaned by damp cloth or water, please install after the sun dry.

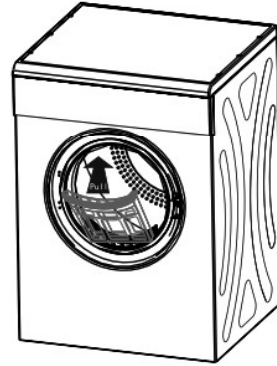

Cleaning cabinet and inner tube

- Use soft damp cloth wipe when cleaning cabinet and inner tube.
- Not to rinse by water direct.
- Not to use neutral scour wipe.
- Not to use gasolene and alcohol wipe.
- Make sure open the front door for aeration after cleaning the inner tube.



Safety reset

1. These dryers have a safety cut out switch which is activated by temperature.
2. The safety reset button is on the backboard. If your dryer not heating this button must be reset before the dryer can heat again. You may need to wait 10 minutes for cooling down.
3. The most common reason for the dryer if overheat is a blocked filter.
4. Clean the line filter after each load to prevent overheating of the dryer

The cut out switch may operate for the following reasons:

1. Lint filter is blocked.
2. Exhaust outlets blocked at the front of the dryer.
3. Poor ventilation in the laundry or room-open a window or door
4. Lightweight garment eg. handkerchief, sucked over the filter.

MAINTENANCES

Safety Reset Button

Use your finger or a pencil to press the button in until you feel it click.

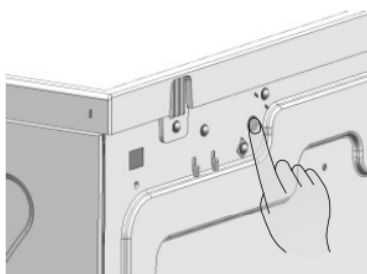

■ Trouble Shooting

Trouble	Cause	Solution
Will not start	<ul style="list-style-type: none"> ● Power cut. ● The power plug is not plugged tight. ● Dry clothes exceed. ● The temperature fuse is cut. 	<ul style="list-style-type: none"> ● Wait for switching on electricity. ● Check the power socket,make sure plug tight. ● The clothes in drier must be after spinning, and drying clothes can not exceed 7kg. ● Please career man restore the temperature fuse.
External hot or can smell hot	<ul style="list-style-type: none"> ● The lint filter is dirty. ● The uptake or exhaust duct is dirty. 	<ul style="list-style-type: none"> ● Make sure clean the lint filter in time. ● Clean out the stem.
Clothes too dry	<ul style="list-style-type: none"> ● The clothes in machine are too full. ● Not to take out the clothes in time when finish. ● The clothes don't assort properly. ● The temperature is enacted too high. 	<ul style="list-style-type: none"> ● Make sure the clothes are not too full. ● Take out the clothes immediately when finish. ● Observe the maintenance label on clothes.
Clothes shrink	<ul style="list-style-type: none"> ● Too dry. 	<ul style="list-style-type: none"> ● Observe the maintenance label on clothes. if easy to shrink,should examine the clothes when dry.Take out the clothes when tiny damp for too dry.Then hang the clothes until full dry.
Hairball on clothes	<ul style="list-style-type: none"> ● It is right for synthetic fibre and permanent press fibre causing hairballs.This is because the right rub causing. 	<ul style="list-style-type: none"> ● Use fabric softener lubricate fibre,please spray settled gule on cuff and neckline when iron clothes.Turn the sarcenet out for reducing rub.

MAINTENANCES

- The sound of dryer when runs can cause
Due to heavy wet clothes' turning and bumping, and this will cause noise accordingly.
- Air bumping: When drying, machine will generate steam which will come out from pipe and this will cost bumping with the bottom of inner tub.

Error code	description	Criteria	Action after fault debounced	Failure indication
E1	Over-temperature	NTC or PCB fault	Stop the program and go to fault state	Led less flashing
E3	Temperature Sensor error	Temperature Sensor is open or PCB fault	Stop the program and go to fault state	Led less and standard flashing
E4	Temperature Sensor error	Temperature Sensor is short or PCB fault	Stop the program and go to fault state	Led extra flashing

■ Technical Specifications

Model	ED-FVD7KGWH
Parameter	
Dimension (L*W*H)	555*595*840(mm)
Rated input power	2000W
Rated voltage	220-240V~
Rated frequency	50Hz
Weight of product	35kg
Rated capacity	7.0kg
Ambient temperature	+5°C~+35°C

Note!

- The rated capacity is the maximum capacity, make sure that the dry clothes which are loaded to the appliance do not exceed the rated capacity each time.
- Do not install the tumble dryer in a room which the temperature around freezing point, and will have a risk of frost occurring, the tumble dryer may not be able to operate well.