

EUROTECH 362 LITRE FRIDGE FREEZER

ED-RFT362SS

INSTRUCTION MANUAL

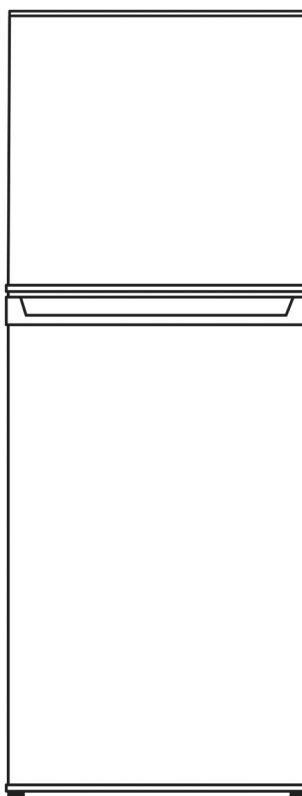

PLEASE READ THIS MANUAL CAREFULLY BEFORE
USING YOUR PRODUCT AND KEEP IT FOR FUTURE
REFERENCE.

Content

1. Safety Information	Page 1~5
2. Overview	Page 6
3. Reverse Door	Page 7~9
4. Installation	Page 10~11
5. Daily Use	Page 12~15
6. Warnings	Page 16

Safety information



In the interest of your safety and to ensure the correct use, before installing and first using the appliance, read this user manual carefully, including its hints and warnings. To avoid unnecessary mistakes and accidents, it is important to ensure that all people using the appliance are thoroughly familiar with its operation and safety features. Save these instructions and make sure that they remain with the appliance if it is moved or sold, so that everyone using it through its life will be properly informed on appliance use and safety.

For the safety of life and property keep the precautions of these user's instructions as the manufacturer is not responsible for damages caused by omission.

Children and vulnerable people safety

- This appliance can be used by children aged from 8 years and above and persons with reduced physical, sensory or mental capabilities or lack of experience and knowledge if they have been given supervision or instruction concerning use of the appliance in a safe way and understand the hazards involved.
- Children should be supervised to ensure that they do not play with the appliance.
- Cleaning and user maintenance shall not be made by children unless they are aged from 8 years and above and supervised.
- Keep all packaging well away from children. There is risk of suffocation.
- If you are discarding the appliance pull the plug out of the socket, cut the connection cable (as close to the appliance as you can) and remove the door to prevent playing children to suffer electric shock or to close themselves into it.
- If this appliance featuring magnetic door seals is to replace an older appliance having a spring lock (latch) on the door or lid, be sure to make that spring lock unusable before you discard the old appliance. This will prevent it from becoming a death trap for a child.

General safety

-  **WARNING!** Keep ventilation openings, in the appliance enclosure or in the built-in structure, clear of obstruction.
-  **WARNING!** Do not use mechanical devices or other means to accelerate the defrosting process, other than those recommended by the manufacturer.
-  **WARNING!** Do not damage the refrigerant circuit.

Safety information

 **WARNING!** Do not use other electrical appliances (such as ice cream makers) inside of refrigerating appliances, unless they are approved for this purpose by the manufacture.

 **WARNING!** Do not touch the light bulb if it has been on for a long period of time because it could be very hot.¹⁾

- Do not store explosive substances such as aerosol cans with a flammable propellant in this appliance.
- The refrigerant isobutane (R600a) is contained within the refrigerant circuit of the appliance, a natural gas with a high level of environmental compatibility, which is nevertheless flammable.
- During transportation and installation of the appliance, be certain that none of the components of the refrigerant circuit become damaged.
 - avoid open flames and sources of ignition
 - thoroughly ventilate the room in which the appliance is situated
- It is dangerous to alter the specifications or modify this product in any way. Any damage to the cord may cause a short circuit, fire and/or electric shock.
- This appliance is intended to be used in household and similar applications such as
 - staff kitchen areas in shops, offices and other working environments;
 - farm houses and by clients in hotels, motels and other residential type environments;
 - bed and breakfast type environments;
 - catering and similar non-retail applications.

 **WARNING!** Any electrical components (plug, power cord, compressor and etc.) must be replaced by a certified service agent or qualified service personnel.

 **WARNING!** The light bulb supplied with this appliance is a “special use lamp bulb” usable only with the appliance supplied. This “special use lamp” is not usable for domestic lighting.¹⁾

¹⁾ If there is a light in the compartment.

Safety information

- Power cord must not be lengthened.
- Make sure that the power plug is not squashed or damaged by the back of the appliance. A squashed or damaged power plug may overheat and cause a fire.
- Make sure that you can come to the mains plug of the appliance.
- Do not pull the mains cable.
- If the power plug socket is loose, do not insert the power plug. There is a risk of electric shock or fire.
- You must not operate the appliance without the lamp.
- This appliance is heavy. Care should be taken when moving it.
- Do not remove nor touch items from the freezer compartment if you hands are damp/wet, as this could cause skin abrasions or frost/freezer burns.
- Avoid prolonged exposure of the appliance to direct sunlight.

Daily use

- Do not put hot on the plastic parts in the appliance.
- Do not place food products directly against the rear wall.
- Frozen food must not be re-frozen once it has been thawed out.¹⁾
- Store pre-packed frozen food in accordance with the frozen food manufacture's instructions.¹⁾
- Appliance's manufactures storage recommendations should be strictly adhered to. Refer to relevant instructions.
- Do not place carbonated or fizzy drinks in the freezer compartment as it creates pressure on the container, which may cause it to explode, resulting in damage to the appliance.¹⁾
- Ice lollies can cause frost burns if consumed straight from the appliance.¹⁾

Care and cleaning

- Before maintenance, switch off the appliance and disconnect the mains plug from the mains socket.
- Do not clean the appliance with metal objects.
- Do not use sharp objects to remove frost from the appliance. Use a plastic scraper.¹⁾
- Regularly examine the drain in the refrigerator for defrosted water. If necessary, clean the drain. If the drain is blocked, water will collect in the bottom of the appliance.²⁾

1) If there is a freezer compartment.

2) If there is a fresh-food storage compartment.

Safety information

- One-, two- and three -star compartments (if they are presented in the appliance) are not suitable for the freezing of fresh food.
- If the appliance is left empty for long periods, switch off, defrost, clean, dry and leave the door open to prevent mould developing within the appliance.

Care and cleaning

- Before maintenance, switch off the appliance and disconnect the mains plug from the mains socket.
- Do not clean the appliance with metal objects.
- Do not use sharp objects to remove frost from the appliance. Use a plastic scraper.¹⁾
- Regularly examine the drain in the refrigerator for defrosted water. If necessary, clean the drain. If the drain is blocked, water will collect in the bottom of the appliance.²⁾

Installation

Important! For electrical connection carefully follow the instructions given in specific paragraphs.

- Unpack the appliance and check if there are damages on it. Do not connect the appliance if it is damaged. Report possible damages immediately to the place you bought it. In that case retain packing.
- It is advisable to wait at least four hours before connecting the appliance to allow the oil to flow back in the compressor.
- Adequate air circulation should be around the appliance, lacking this leads to overheating. To achieve sufficient ventilation follow the instructions relevant to installation.
- Wherever possible the spacers of the product should be against a wall to avoid touching or catching warm parts (compressor, condenser) to prevent possible burn.
- The appliance must not be located close to radiators or cookers.
- Make sure that the mains plug is accessible after the installation of the appliance.

Service

- Any electrical work required to do the servicing of the appliance should be carried out by a qualified electrician or competent person.
- This product must be serviced by an authorized Service Center, and only genuine spare parts must be used.

Energy saving

- Don't put hot food in the appliance;
- Don't pack food close together as this prevents air circulating;
- Make sure food don't touch the back of the compartment(s);

1) If there is a freezer compartment.

2) If there is a fresh-food storage compartment.

Safety information

Installation

Important! For electrical connection carefully follow the instructions given in specific paragraphs.

- Unpack the appliance and check if there are damages on it. Do not connect the appliance if it is damaged. Report possible damages immediately to the place you bought it. In that case retain packing.
- It is advisable to wait at least four hours before connecting the appliance to allow the oil to flow back in the compressor.
- Adequate air circulation should be around the appliance, lacking this leads to overheating. To achieve sufficient ventilation follow the instructions relevant to installation.
- Wherever possible the spacers of the product should be against a wall to avoid touching or catching warm parts (compressor, condenser) to prevent possible burn.
- The appliance must not be located close to radiators or cookers.
- Make sure that the mains plug is accessible after the installation of the appliance.

Service

- Any electrical work required to do the servicing of the appliance should be carried out by a qualified electrician or competent person.
- This product must be serviced by an authorized Service Center, and only genuine spare parts must be used.

Energy saving

- Don't put hot food in the appliance;
- Don't pack food close together as this prevents air circulating;
- Make sure food don't touch the back of the compartment(s);
- If electricity goes off, don't open the door(s);
- Don't open the door(s) frequently;
- Don't keep the door(s) open for too long time;
- Don't set the thermostat on exceeding cold temperatures;
- Some accessories, such as drawers, can be removed to get larger storage volume and lower energy consumption.

Overview

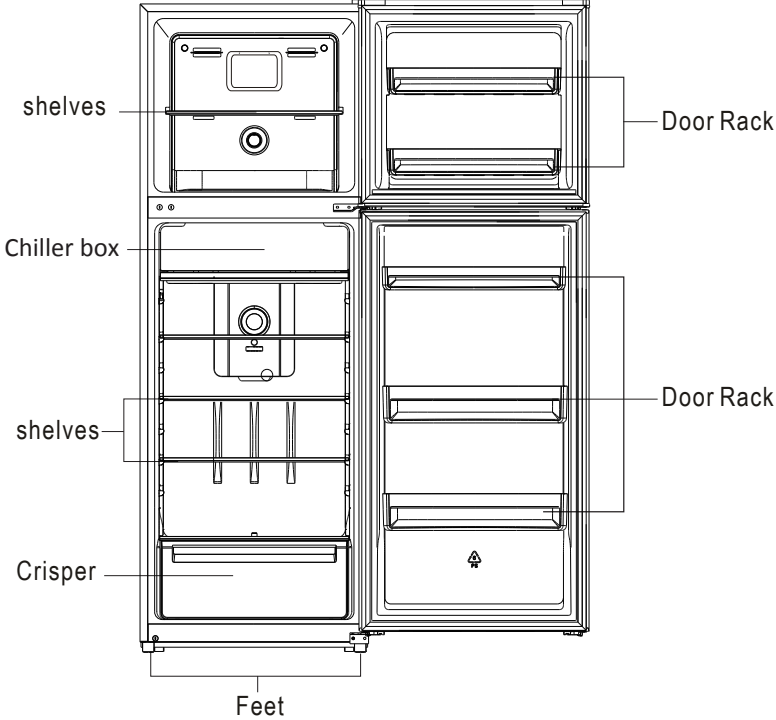

Note: Above picture is for reference only. The actual appliance maybe slightly different.

Reverse Door

Tool required: Philips screwdriver, Flat bladed screwdriver, Hexagonal spanner.

- Ensure the unit is unplugged and empty.
- To take the door off, it is necessary to tilt the unit backwards. You should rest the unit on something solid so that it will not slip during the door reversing process.
- All parts removed must be saved to do the reinstallation of the door.
- Do not lay the unit flat as this may damage the coolant system.
- It's better that 2 people handle the unit during assembly.

1. Unscrew top hinge cover and then unscrew the top hinge .
Then lift upper door and place it on a soft pad to avoid scratch and damage.

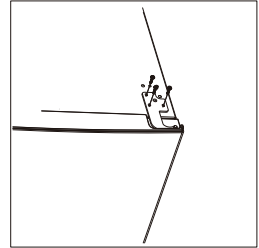
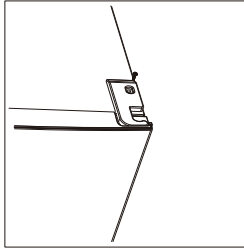

2. Remove the pin with a screwdriver and flip the hinge bracket. Then refit the pin to hinge bracket.

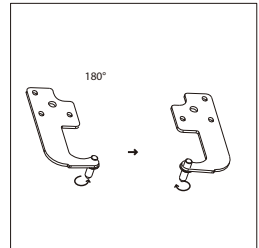

3. Remove the top left screw cover.

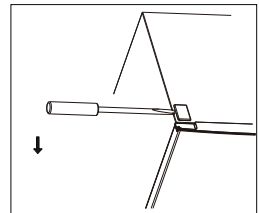

4. Unscrew middle hinge.

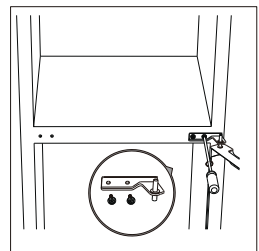

Reverse Door

5. Move shaft sleeve and pin hole plug from left side to right side.

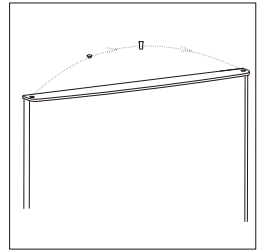

6. Move the hinge hole covers from left side to right side.

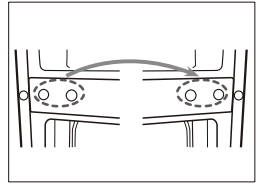

7. Unscrew bottom hinge. Then remove the adjustable feet from both side.

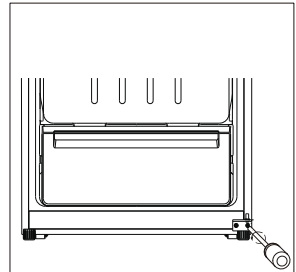
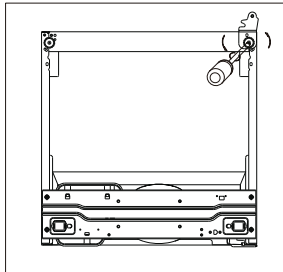

8. Disassemble right hinge, find out right bottom hinge from spare parts bags and fix it.

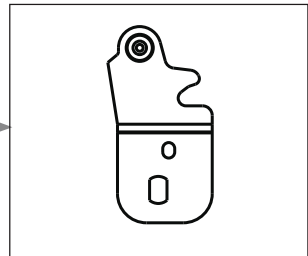
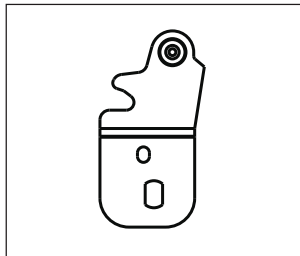

Reverse Door

9. Refit the bracket fitting the bottom hinge pin. Replace both adjustable feet. Transfer the lower door to the property position.

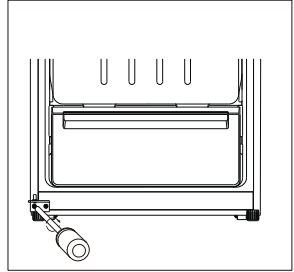
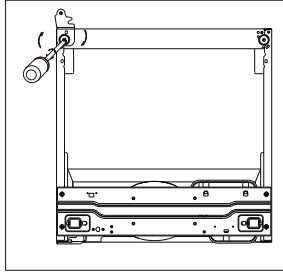

10. Make the middle hinge reverse the direction 180°C, then transfer it to the left property position. Make the middle hinge pin in the upper hole of the lower door, then tight the bolts.

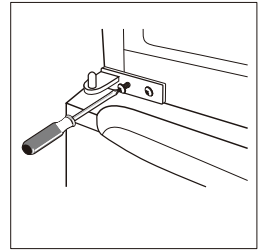

11. Place the upper door back on. Ensure the door is aligned horizontally and vertically so that the seal are closed on all sides before finally tightening the top hinge. Then insert the top hinge and screw it to the top of unit and then fix hinge cover (in accessory bag) by screw.

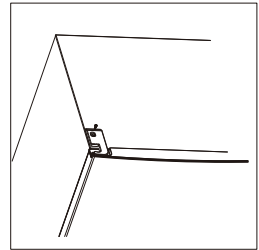
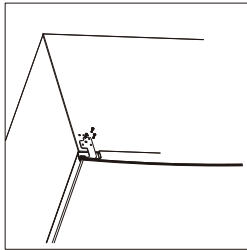

12. Fix the screw cover.

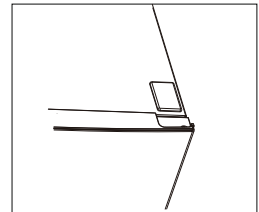

Installation

Space Requirement

- Select a location without direct exposure to sunlight;
- Select a location with enough space for the refrigerator doors to open easily;
- Select a location with level (or nearly level) flooring;
- Allow sufficient space to install the refrigerator on a flat surface;
- Allow clearance to the right, left, back and top when installing. This will help reduce power consumption and keep your energy bills lower.

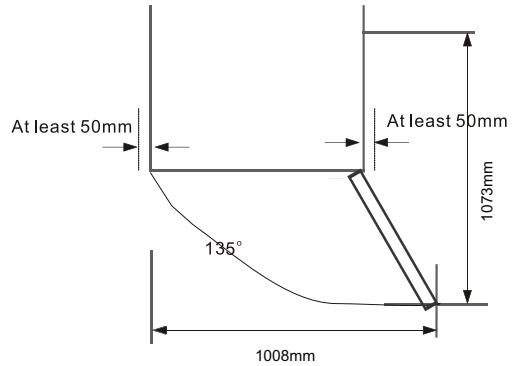
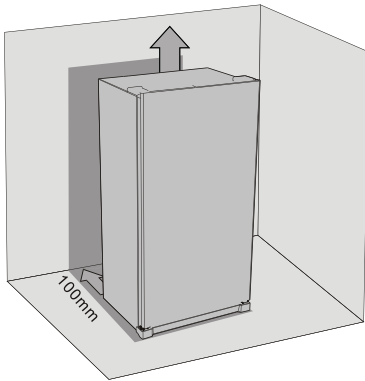

Levelling the refrigerator

Levelling the unit

To do this adjust the two levelling feet at front of the unit.

If the unit is not level, the doors and magnetic seal alignments will not be covered properly.

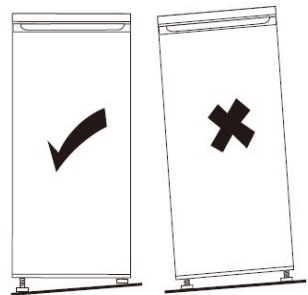

Installation

Positioning

Install this appliance at a location where the ambient temperature corresponds to the climate class indicated on the rating plate of the appliance:

Climate class	Ambient temperature
SN	+10°C to +32°C
N	+16°C to +32°C
ST	+16°C to +38°C
T	+16°C to +43°C

Location

The appliance should be installed well away from sources of heat such as radiators, boilers, direct sunlight etc. Ensure that air can circulate freely around the back of the cabinet. To ensure best performance, if the appliance is positioned below an overhanging wall unit, the minimum distance between the top of the cabinet and the wall unit must be at least 100 mm. Ideally, however, the appliance should not be positioned below overhanging wall units. Accurate leveling is ensured by one or more adjustable feet at the base of the cabinet.

 **Warning!** It must be possible to disconnect the appliance from the mains power supply; the plug must therefore be easily accessible after installation.

Electrical connection

Before plugging in, ensure that the voltage and frequency shown on the rating plate correspond to your domestic power supply. The appliance must be earthed. The power supply cable plug is provided with a contact for this purpose.

Daily Use

Using the Control Panel

Freezer compartment Temperature Setting

- Plug on your appliance. The internal temperature is controlled by a sensor. There are 3 settings **COLD**, **RECOMMENDED** and **COLDEST**. **COLD** is warmest setting and **COLDEST** is coldest setting.
- The appliance may not operate at the correct temperature if it is in a particularly hot or if you open the door often.



FREEZER CONTROL

Fridge compartment Temperature Setting

- Plug on your appliance. The internal temperature is controlled by a sensor. There are 4 settings **OFF**, **COLD**, **RECOMMENDED** and **COLDEST**. **COLD** is warmest setting and **COLDEST** is coldest setting and **OFF** is off .
- The appliance may not operate at the correct temperature if it is in a particularly hot or if you open the door often.
- Neither fridge or freezer compartment works when the setting is **OFF**.

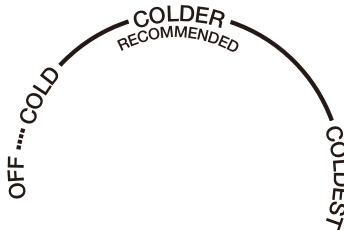

TEMPERATURE CONTROL

Daily Use

First use

Cleaning the interior

Before using the appliance for the first time, wash the interior and all internal accessories with lukewarm water and some neutral soap so as to remove the typical smell of a brand new product, then dry thoroughly.

Important! Do not use detergents or abrasive powders, as these will damage the finish.

Daily use

Freezing fresh food

- The freezer compartment is suitable for freezing fresh food and storing frozen and deep-frozen food for a long time.
- Place the fresh food to be frozen in the bottom compartment.
- The maximum amount of food that can be frozen in 24 hours is specified on the rating plate.
- The freezing process lasts 24 hours: during this period do not add other food to be frozen.

Storing frozen food

When first starting-up or after a period out of use, before putting the product in the compartment let the appliance run at least 2 hours on the higher settings.

Important! In the event of accidental defrosting, for example the power has been off for longer than the value shown in the technical characteristics chart under "rising time", the defrosted food must be consumed quickly or cooked immediately and then re-frozen (after cooked).

Thawing

Deep-frozen or frozen food, prior to be used, can be thawed in the fridge compartment or at room temperature, depending on the time available for this operation.

Small pieces may even be cooked still frozen, directly from the freezer. In this case, cooking will take longer.

Accessories

Movable shelves

The walls of the refrigerator are equipped with a series of runners so that the shelves can be positioned as desired.

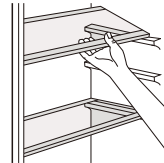

Positioning the door balconies

To permit storage of food packages of various sizes, the door balconies can be placed at different heights. To make these adjustments proceed as follows: gradually pull the balcony in the direction of the arrows until it comes free, then reposition as required.

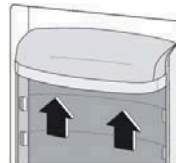

Daily Use

Helpful hints and tips

Hints for freezing

To help you make the most of the freezing process, here are some important hints:

- the maximum quantity of food which can be frozen in 24 hrs. is shown on the rating plate;
- the freezing process takes 24 hours. No further food to be frozen should be added during this period;
- only freeze top quality, fresh and thoroughly cleaned, foodstuffs;
- prepare food in small portions to enable it to be rapidly and completely frozen and to make it possible subsequently to thaw only the quantity required;
- wrap up the food in aluminium foil or polythene and make sure that the packages are airtight;
- do not allow fresh, unfrozen food to touch food which is already frozen, thus avoiding a rise in temperature of the latter;
- lean foods store better and longer than fatty ones; salt reduces the storage life of food;
- water ices, if consumed immediately after removal from the freezer compartment, can possibly cause the skin to be freeze burnt;
- it is advisable to show the freezing in date on each individual pack to enable you removal from the freezer compartment, can possibly cause the skin to be freeze burnt;
- it is advisable to show the freezing in date on each individual pack to enable you to keep tab of the storage time.

Hints for storage of frozen food

To obtain the best performance from this appliance, you should:

make sure that the commercially frozen foodstuffs were adequately stored by the retailer;

be sure that frozen foodstuffs are transferred from the food store to the freezer in the shortest possible time;

not open the door frequently or leave it open longer than absolutely necessary.

Once defrosted, food deteriorates rapidly and cannot be refrozen.

Do not exceed the storage period indicated by the food manufacture.

Hints for fresh food refrigeration

To obtain the best performance:

- Do not store warm food or evaporating liquids in the refrigerator
- Do cover or wrap the food, particularly if it has a strong flavour

Hints for refrigeration

Useful hints:

- Make (all types): wrap in polythene bags and place on the glass shelves above the vegetable drawer.
- For safety, store in this way only one or two days at the most.
- Cooked foods, cold dishes, etc...: these should be covered and may be placed on any shelf.
- Fruit and vegetables: these should be thoroughly cleaned and placed in the special drawer(s) provided.
- butter and cheese: these should be placed in special airtight containers or wrapped in aluminium foil or polythene bags to exclude as much air as possible.
- Milk bottle: these should have a cap and should be stored in the balconies on the door.
- Bananas, potatoes, onions and garlic, if not packed, must not be kept in the fridge.

Cleaning

For hygienic reasons the appliance interior, including interior accessories, should be cleaned regularly.



Caution! The appliance may not be connected to the mains during cleaning. Danger of electrical shock! Before cleaning switch the appliance off and remove the plug from the mains, or switch off or turn out the circuit breaker or fuse. Never clean the appliance with a steam cleaner. Moisture could accumulate in electrical components, danger of electrical shock! Hot vapors can lead to the damage of plastic parts. The appliance must be dry before it is placed back into service.

Important! Ethereal oils and organic solvents can attack plastic parts, e.g. lemon juice or the juice from orange peel, butyric acid, cleanser that contain acetic acid.

- Do not allow such substances to come into contact the appliance parts.
- Do not use any abrasive cleaners
- Remove the food from the freezer. Store them in a cool place, well covered.
- Switch the appliance off and remove the plug from the mains, or switch off or turn out the circuit breaker of fuse.
- Clean the appliance and the interior accessories with a cloth and lukewarm water. After cleaning wipe with fresh water and rub dry.
- After everything is dry place appliance back into service.

Daily Use

Troubleshooting

 **Caution!** Before troubleshooting, disconnect the power supply. Only a qualified electrician OR competent person must do the troubleshooting that is not in this manual.

Important! There will be some sound/noise during normal operation (compressor or refrigerant circulation).

Problem	Possible cause	Solution
Appliance does not work	Mains plug is not plugged in or is loose	Insert mains plug.
	Fuse has blown or is defective	Check fuse, replace if necessary.
	Socket is defective	Mains malfunctions are to be corrected by an electrician.
Appliance freezes or cools too much	Temperature is set too cold or the appliance runs at SUPER modes.	Turn the temperature regulator to a warmer setting temporarily.
The food is not frozen enough.	Temperature is not properly adjusted.	Please look in the initial Temperature Setting section.
	Door was open for an extended period.	Open the door only as long as necessary.
	A large quantity of warm food was placed in the appliance within the last 24 hours.	Turn the temperature regulation to a colder setting temporarily.
	The appliance is near a heat source.	Please look in the installation location section.
Heavy build up of frost on the door seal.	Door seal is not air tight.	Carefully warm the leaking sections of the door seal with a hair dryer (on a cool setting). At the same time shape the warmed door seal by hand such that it sits correctly.
Unusual noises	Appliance is not level.	Re-adjust the feet.
	The appliance is touching the wall or other objects.	Move the appliance slightly.
	A component, e.g. a pipe, on the rear of the appliance is touching another part of the appliance or the wall.	If necessary, carefully bend the component out of the way.

If the malfunction shows again, contact the Service Center.

Warnings

- * This appliance is not intended for use by persons (including children) with reduced physical, sensory or mental capabilities, or lack of experience and knowledge, unless they have been given supervision or instruction concerning use of the appliance by a person responsible for their safety.
- * Children should be supervised to ensure that they do not play with the appliance. If the supply cord is damaged, it must be replaced by the manufacturer, its service agent or similarly qualified persons in order to avoid a hazard.
- * Keep ventilation openings, in the appliance enclosure or in the built-in structure, clear of obstruction.
- * Do not use mechanical devices or other means to accelerate the defrosting process, other than those recommended by the manufacturer.
- * Do not damage the refrigerant circuit
- * Do not use electrical appliances inside the food storage compartments of the appliance, unless they are of the type recommended by the manufacturer.

IMPORTANT DISPOSAL INSTRUCTIONS



As a responsible retailer we care about the environment.

As such we urge you to follow the correct disposal procedure for your product and packaging materials. This will help conserve natural resources and ensure that it is recycled in a manner that protects health and the environment.

You must dispose of this product and its packaging according to local laws and regulations. Because this product contains electronic components and sometimes batteries, the product and its accessories must be disposed of separately from household waste when the product reaches its end of life. Contact your local authority to learn about disposal and recycling.

The product should be taken to your local collection point for recycling.

Some collection points accept free of charge.

We apologise for any inconvenience caused by minor inconsistencies in these instructions, which may occur as a result of product improvement and development.