

7kg Washer Dryer

ED-WDC74WH

INSTRUCTION MANUAL

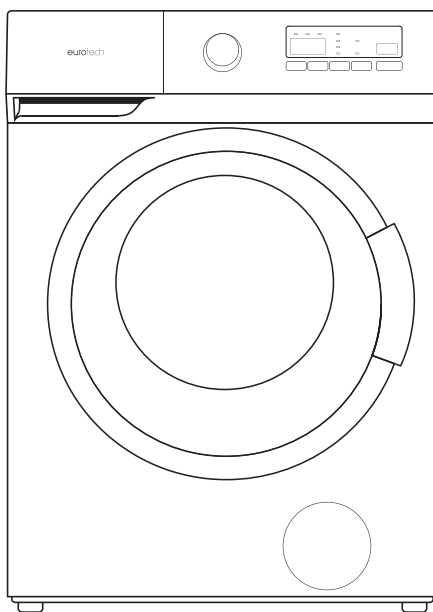

CONTENTS

SAFETY INSTRUCTIONS

- Safety Instructions 2

INSTALLATION

- Product Description 9
- Installation 10

OPERATION

- Quick Start 13
- Before Each Washing 14
- Detergent Dispenser 15
- Control Panel 16
- Programmes.....17
- Option.....20
- Other Functions 22

MAINTENANCE

- Cleaning and Care 24
- Trouble Shooting 27
- Technical Specifications 28
- Product Fiche 29

SAFETY INSTRUCTIONS

■ Safety Instructions

Please read the following safety information thoroughly and follow it strictly to minimize the risk of fire or explosion, electric shock and to prevent property damage, personal injury or loss of life. Failing to follow these instructions shall void any warranty.

Warning!

This combination of symbol and signal word indicates a potentially dangerous situation which may result in death or serious injuries unless it's avoided.

Caution!

This combination of symbol and signal word indicates a potentially dangerous situation which may result in slight or minor injuries or damage to property and the environment.

Note!

This combination of symbol and signal word indicates a potentially dangerous situation which may result in slight or minor injuries.

Warning!

ELECTRIC SHOCK HAZARD

- If the supply cord is damaged, it must be replaced by a special cord or assembly available from the manufacturer or its service agent.
 - If the machine is damaged, it must not be operated unless repaired by the manufacturer, its service agent or similarly qualified persons.
- Risk of electric shock!

SAFETY INSTRUCTIONS

RISK TO CHILDREN!

- This appliance is not intended for use by persons (including children) with reduced physical, sensory or mental capabilities, or lack of experience and knowledge, unless they have been given supervision or instruction concerning use of the appliance by a person responsible for their safety.
- Children should be supervised to ensure that they do not play with the appliance.
- Children 3 years and under shall be kept away from the appliance or continuously supervised.
- Animals and children may climb into the machine. Check the machine before every operation.
- Do not climb or sit on the appliance.

INSTALLATION LOCATION AND SURROUNDING

- All washing and additional substances are to be kept in a safe place out of the reach of children.
- Do not install the machine on a carpet floor. The obstruction of the openings by a carpet can damage the machine.
- Keep the appliance clear from heating sources and direct sunlight to avoid plastic and rubber parts to corrode.
- Do not use the appliance in humid environments or rooms containing explosive or caustic gas. In case of water leakage or water splashes let the appliance dry in the open air.
- The appliance must not be installed behind a lockable door, a sliding door or a door with a hinge on the opposite side to that of the tumble dryer, in such a way that a full opening of the tumble dryer door is restricted.

SAFETY INSTRUCTIONS

- Do not operate the machine in rooms with a temperature of below 5°C. This can cause damages to parts of it. If it is unavoidable, make sure to drain the water completely from the appliance after every use (see „Maintenance - Cleaning of drain pump filter“) to avoid damages caused by frost.
- Never use flammable sprays or substances in the immediate proximity of the appliance.

INSTALLATION

- The maximum inlet water pressure:1.0Mpa.
- The minimum inlet water pressure:0.05Mpa.
- Remove all packaging material and transport bolts before using the appliance. Otherwise, serious damage may result.
- This appliance is equipped with a single inlet valve and can be connected to the cold water supply only.
- Mains plug must be accessible after installation.
- Before washing clothes for the first time, the product shall be operated once throughout all the procedures without any clothes inside.
- Before using the washer dryer, the product shall be calibrated.
- Do not put any excessively heavy objects on the appliance, like water containers or heating devices.
- The new hose-sets supplied with the appliance are to be used and that old hose-sets should not be reused.

SAFETY INSTRUCTIONS

ELECTRICAL CONNECTION

- Make sure the supply cable is not trapped by the machine, it can get damaged.
- Connect the product to a grounded outlet protected by a fuse complying with the values in the " Technical specifications " table. The grounding installation has to be made by a qualified electrician. Ensure that the machine is installed in accordance with the local regulations.
- Water and electrical connections must be carried out by a qualified technician in accordance with the manufacturer's instructions and local safety regulations.

Warning!

- Don't use multiple plugs or extension cords.
- The appliance must not be supplied through an external switching device, such as a timer, or connected to a circuit that is regularly switched on and off by a utility.
- Do not pull the plug out of the mains outlet if there is flammable gas around.
- Never pull out power plug with wet hands.
- Always pull at the plug, not at the cable.
- Always unplug the appliance if it is not being used.

WATER CONNECTIONS

- Check the connections of the water inlet tubes, the water tap and the outlet hose for possible problems due to changes of water pressure. If the connections loosen or leak close the water tap and get it repaired. Do not use the appliance before the pipes and hoses are installed properly by qualified persons.
- Glass door may become very hot during the operation. Keep children and pets far away from the machine while it is operating.
- The water inlet and outlet hoses have to be safely installed and remain undamaged. Otherwise, water leakage can occur.
- Do not remove the drain pump filter while there is still water in the appliance. Big quantities of water can leak out, and there is a risk of scalding due to hot water.

SAFETY INSTRUCTIONS

OPERATION AND MAINTENANCE

Warning!

- Never stop the washer dryer before the end of the drying cycle unless all items are quickly removed and spread out so that the heat can dissipate.
- The washer dryer is not to be used if industrial chemicals have been used for cleaning. Risk of explosion.

- Never use any flammable, explosive or toxic solvents. Do not use gasoline and alcohol etc. as detergents. Only select detergents that are suitable for machine washing.
- Make sure that all pockets are emptied. Sharp and rigid items such as coins, brooches, nails, screws, stones etc. may cause serious damages to this machine.
- Remove all objects from pockets such as lighters and matches before use the appliance.
- Thoroughly rinse items that have been washed by hand.
- Do not dry unwashed items in the appliance.
- Items that have been soiled with substances such as cooking oil, acetone, alcohol, petrol, kerosene, spot removers, turpentine, waxes and wax removers should be washed in hot water with an extra amount of detergent before being dried in the appliance.
- Items such as foam rubber (latex foam), shower caps, waterproof textiles, rubber backed articles and clothes or pillows fitted with foam rubber pads should not be dried in the appliance.
- Fabric softeners, or similar products, should be used as specified by the fabric softener instructions.
- Fill steam generators only with liquids specified by the manufacturer.
- Oil-affected items can ignite spontaneously, especially when exposed to heat sources such as in a tumble dryer. The items become warm, causing an oxidation reaction in the oil. Oxidation creates heat. If the heat cannot escape, the items can become hot enough to catch fire. Piling, stacking or storing oil-affected items can prevent heat from escaping and so create a fire hazard.

SAFETY INSTRUCTIONS

- If it is unavoidable that fabrics that contain vegetable or cooking oil or have been contaminated by hair care products be placed in a tumble dryer they should first be washed in hot water with extra detergent - this will reduce, but not eliminate, the hazard.
- Never try to open the door forcefully. The door will unlock shortly after the end of a cycle.
- Please do not close the door with excessive force. If it is found difficult to close the door, please check if the clothes are properly inserted and distributed.
- Lint must not be allowed to accumulate around the appliance.
- Always unplug the appliance and close the water tap before cleaning and maintenance and after each use.
- Never pour water over the appliance for cleaning purpose. Risk of electric shock!
- Repairs shall only be carried out by the manufacturer, its service agent or similarly qualified persons in order to avoid a hazard. The producer will not be responsible for damages caused by the intervention of not authorized persons.

TRANSPORT

- Before Transport:
 - Bolts shall be reinstalled to the machine by a specialized person
 - Accumulated water shall be drained out of the machine
- This appliance is heavy. Transport with care. Never hold any protruding part of the machine when lifting. The machine door cannot be used as a handle.

SAFETY INSTRUCTIONS

INTENDED USE

- The maximum mass of dry cloth in kilograms: 8.0kg.
- The maximum mass of dry textile material in kilograms: 4.0kg.
- The product is intended only for home use and for textiles in household amounts suitable for machine washing and drying. This appliance is for indoor use only and not intended for built in use. Only use according to these instructions. The appliance is not intended for commercial use.

Any other use is considered as improper use. The producer is not responsible for any damage or injuries that may result of it.

•This appliance is intended to be used in household and similar applications such as:

- Staff kitchen areas in shops, offices and other working environments;
- Farm houses;
- By clients in hotels, motels and other residential type environments;
- Bed and breakfast type environments;
- Areas for communal use in blocks of flats or in launderettes.

Packaging/Old appliance



This marking indicates that this product should not be disposed with other household wastes throughout the EU. To prevent possible harm to the environment or human health from uncontrolled waste disposal, recycle it responsibly to promote the sustainable reuse of material resources. To return your used device, please use the collection systems or contact the retailer where the product was purchased. They return and can take this product for environmental safe recycling.

INSTALLATION

■ Product Description

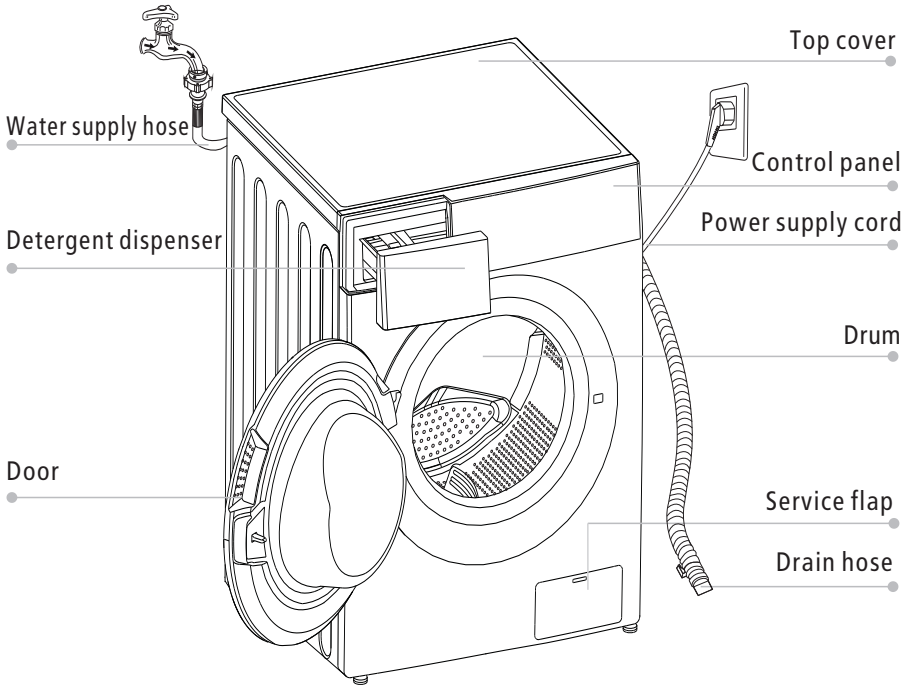

Note!

- The product picture is for illustration only, please refer to real product as reference.

Accessories

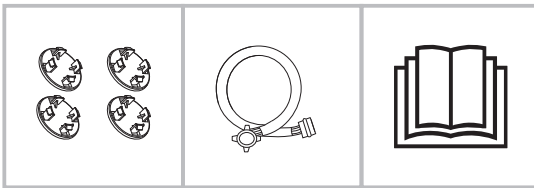

4 x Cover caps

1 x Supply hose
cold water

1 x Owner's manual

INSTALLATION

■ Installation

Installation area

⚠ Warning!

- Stability is important to prevent the product from wandering! Make sure the machine is standing leveled and stable.
- Make sure that the product does not stand onto the power cord.
- Make sure to maintain the minimum distances from the walls as shown in the picture

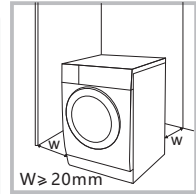

Before installing the machine, the location characterized as follows shall be selected:

1. Rigid, dry, and level surface
2. Avoid direct sunlight
3. Sufficient ventilation
4. Room temperature is above 0°C
5. Keep far away from the heat sources such as coal or gas burning appliances.

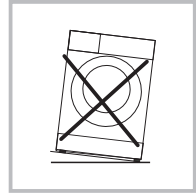

Unpacking the washer dryer

⚠ Warning!

- Packaging material (e.g. Films, Styrofoam) can be dangerous for children.
- There is a risk of suffocation ! Keep all packaging well away from children.

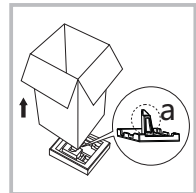

1. Remove the cardboard box and styrofoam packing.
2. Lift the washer dryer and remove the base packaging. Make sure the small triangle foam (a) is removed with the bottom packaging together. If not, lay the unit down on the side surface and remove it manually.
3. Remove the tape securing the power supply cord and drain hose.
4. Remove the inlet hose from the drum.

INSTALLATION

Remove transport bolts

⚠ Warning!

- You must remove the transport bolts from the backside before using the product.



Loosen the 4 transport bolts with a spanner.

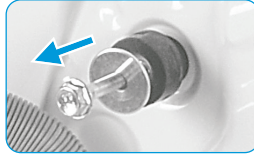

Remove the bolts including the rubber parts and keep them for future use.

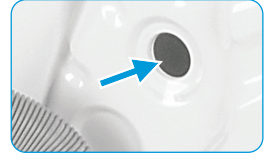

Close the holes using the cover caps.

Levelling the washer dryer

⚠ Warning!

- The lock nuts on all four feet must be screwed tightly against the housing.

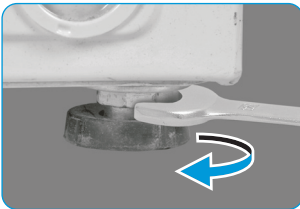

1. Loosen the lock nut.
2. Turn the foot until it reaches the floor.
3. Adjust the legs and lock the nuts with a spanner. Make sure the machine is level and steady.

Connect the water supply hose

⚠ Warning!

To prevent leakage or water damage, follow the instructions in this chapter

- Do not kink, crush or modify water inlet hose.



Connect the water supply hose to the water inlet valve and a water tap with cold water as indicated.



🔧 Note!

- Connect manually, do not use tools. Check if the connections are tight.

INSTALLATION

Drain Hose

⚠ Warning!

- Do not kink or protract the drain hose.
- Position drain hose properly ,otherwise damage might result of water leakage.

There are two ways to place the end of drain hose:

1.Put it into the water trough.

2.Connect it to the branch drain pipe of the trough.

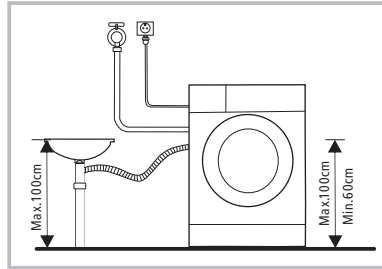
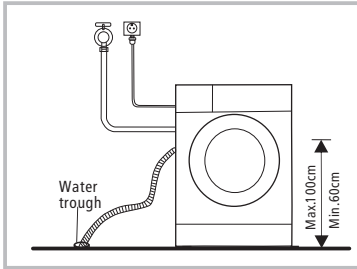

OPERATION

■ Quick Start

⚠ Caution!

- Before washing, please make sure the washer dryer is installed properly.
- Your appliance was thoroughly checked before it left the factory. To remove any residual water and to neutralize potential odors, it's recommended to clean your appliance before first use. For this reason, start the Cotton program at 90°C without laundry and detergent.

1. Before Washing

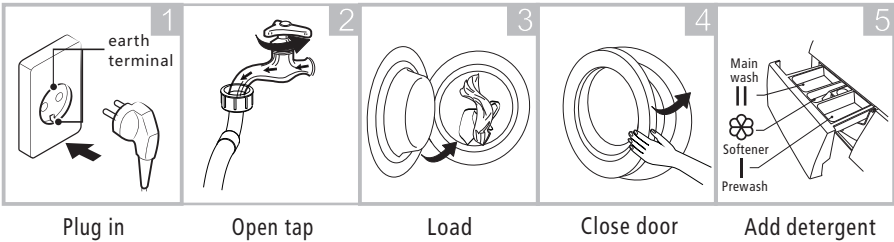

📌 Note!

- Detergent need to be added in compartment I if the pre-wash function is selected.

2. Washing

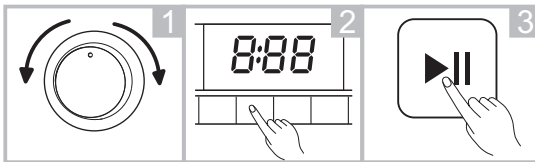

Select programme Select function or remain default settings Press Start/Pause to start the program

3. After Washing

Buzzer beep and "End" on display.

OPERATION

■ Before Each Washing

- The ambient temperature of the washer dryer should be 5-40°C. If used under 0°C, the inlet valve and draining system may be damaged. If the machine is installed under freezing conditions, it should be transferred to normal ambient temperature to ensure the water supply hose and drain hose can unfreeze before use.
- Please check your laundry care labels and the detergent use instructions before wash. Use non-foaming or less-foaming detergent suitable for machine washing properly.

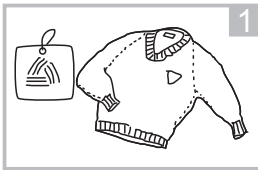

Check the care label

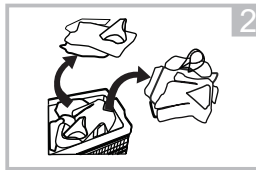

Sort laundry according to color and textile type

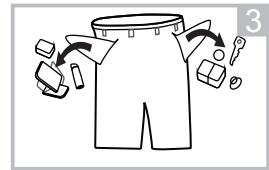

Take all items out of the pockets

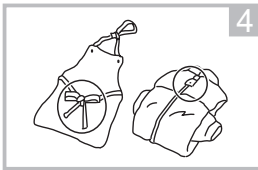

Tie together long textile strips and belts, close zips and button

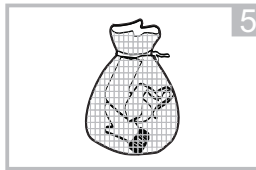

Put small items into a laundry bag

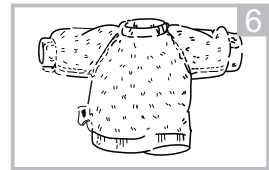

Turn easy-pilling and long-pile fabric inside out

⚠ Warning!

- Do not wash or dry articles that have been cleaned in, washed in, soaked in, or dabbed with combustible or explosive substances like wax, oil, paint, gasoline, alcohol, kerosene, and other flammable materials.
- Washing single clothes items may easily create big eccentricity and cause alarm due to unbalance. Therefore it is suggested to add one or two more laundry items to the wash so that spin can be done smoothly.

OPERATION

■ Detergent Dispenser

- I Pre wash
- II Main wash
- ☼ Softener
- ⊖ Release button to pull out the dispenser

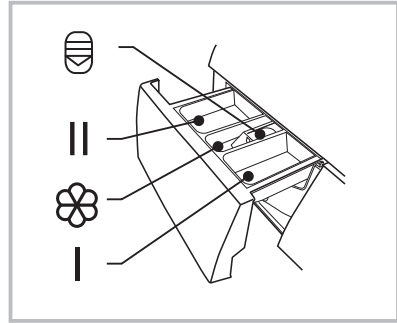

⚠ Caution!

- Detergent only need to be added in "compartment I "after selecting pre-wash function.

Programme	I	II	☼	Programme	I	II	☼
Sport Wear		●	○	*Dry Only			
Quick 15'		●	○	*Synthetic		●	○
Jeans		●	○	*Mix		●	○
Delicate		●	○	*1 Hour W/D		●	○
Spin Only				*Cotton		●	○
Rinse & Spin			○	*Wash&Dry		●	○
Cotton ECO		●	○	Intensive		●	○
20°C		●	○				

● Means must ○ Means optional

OPERATION

Control Panel

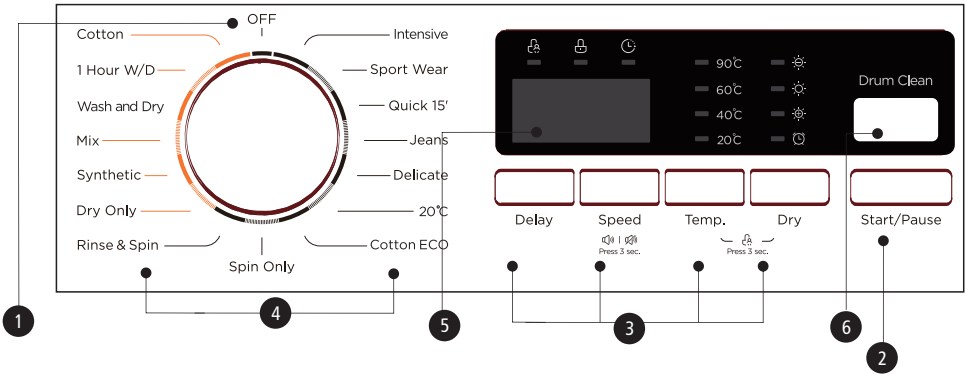

1 On/Off

Turn the appliance on and off.

2 Start/Pause

Start or pause your programme.

3 Option

This allows you to select additional functions and will light when selected.

4 Programmes

Available according to the laundry type.

5 Display

The display shows settings, estimated remaining time, options and status messages.

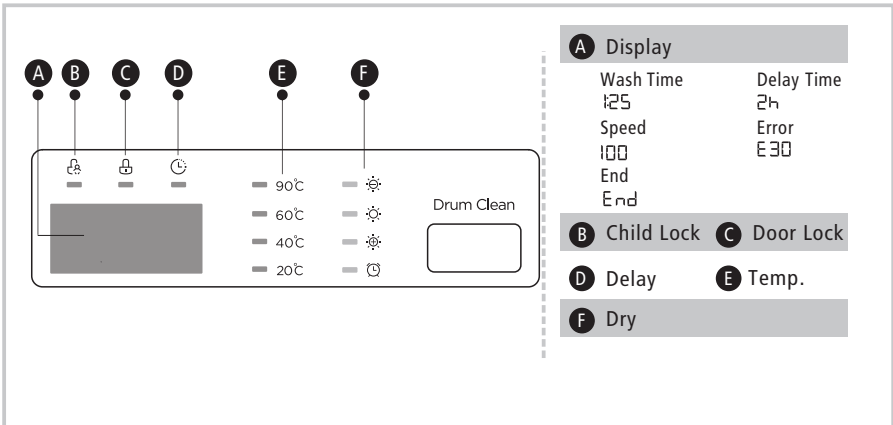

OPERATION

■ Programmes

Programme	Load(kg)	Display Time
	7kg Wash/Dry	7.0
Intensive	7.0	3:48
Sport Wear	3.5	0:45
Quick 15'	2.0	0:15
Jeans	7.0	1:32
Delicate	2.5	0:49
20°C	3.5	1:01
Cotton ECO	7.0	0:59
Spin Only	7.0	0:12
Rinse & Spin	7.0	0:20
☀ Dry Only	4.0	4:14
☀ Synthetic	3.5/3.5	1:28
☀ Mix	7.0/4.0	0:58
☀ Wash and Dry	3.5	5:24
☀ 1Hour W/D	1.0	0:58
☀ Cotton	7.0/4.0	1:28
Drum Clean	--	1:18

- Energy test program: Cotton ECO, 60°C
Speed: the highest speed; Other as the default.
Half load for 7.0kg machine:3.5kg.
- "Cotton ECO, 60°C " is the standard washing programs to which the information in the label and the fiche relates, and they are suitable to clean normally soiled cotton laundry and that they are the most efficient programmes in terms of combined energy and water consumptions for washing that type of cotton laundry, that the actual water temperature may differ from the declared cycle temperature.

Note!

- The parameters in this table are only for user's reference. The actual parameters maybe different with the parameters in above mentioned table.

OPERATION

■ Programmes

Programmes are available according to the laundry type.

Programmes	
Cotton	Hard-wearing textiles, heat-resistant textiles made of cotton or linen.
Synthetic	Wash synthetic articles, for example: shirts, coats, blending. While washing the knitting textiles, detergent quantity shall be reduced due to its loose string construction and easily forming bubbles.
Mix	Mixed load consisting of textiles made of cotton and synthetics.
Jeans	Specially for jeans.
20°C	Washing brightly colored clothes, it can protect the colors better.
Quick 15'	Extra short programme approx, suitable for lightly soiled washing as a small amounts of laundry.
Delicate	For delicate, washable textiles, e.g. made of silk, satin, synthetic fibres or blended fabrics.
Spin Only	Extra spin with selectable spin speed.
Rinse&Spin	Extra rinse with spin.
Drum Clean	Specially set in this machine to clean the drum and tube. It applies 90 °C high temperature sterilization to make the clothes washing more green. When this programme is performed, the clothes or other washing cannot be added. When proper amount of chlorine bleaching agent is put in, the barrel cleaning effect will be better. The customer can use this programme regularly according to the need.
Sport Wear	Washing the activewear.

OPERATIONS

Programmes

Dry Only Select it to dry clothes, the temperature is different .The drying time according to the load .

1 Hour W/D For small synthetic clothes or shirts, load limitation is 1 kg (about 4 shirts). When you have an urgent appointment but no more clean shirt left in your cupboard, this program will help you. Time duration is only 1 hour including wash and dry. Remark: Big towels or jeans is not suitable for this program, they will enlarge the time duration and affect the moisture content.

Cotton ECO As for few light dirty clothes, the maximum temperature of washing is limited to 40°C, and saving more energy.

Intensive To increase the washing effects, washing time is increased.

Wash & Dry The standard energy program.



Note!

- Reference to your product to select the programmes.

OPERATION

■ Options

Cycle	Default Temp.(°C)	Default spin speed in rpm	Additional functions
1400			
Intensive	40	800	☺,
Sport Wear	20	800	☺,
Quick 15'	Cold	800	☺,
Jeans	20	800	☺,
Delicate	20	800	☺,
20°C	20	1000	☺,
Cotton ECO	20	1000	☺,
Spin Only	--	1000	☺,
Rinse & Spin	--	1000	☺,
Dry Only	--	1400	☺,
Synthetic	40	800	☺,
Mix	40	1000	☺,
Wash and Dry	40	1400	☺,
1 Hour W/D	Cold	--	☺,
Cotton	40	1000	☺,
Drum Clean	90	--	☺,

Note!

- The table shows which cycle offers which options for adjustment. If an adjustment is not possible for a cycle.

OPERATION

Temp.

Temp.

When needed, the washing temperature can be adjusted by pressing the temperature button in the following steps: Cold - 20°C - 40°C - 60°C - 90°C.

Speed

Spin Speed

When needed, the spinning speed can be adjusted pressing the Speed button in the following steps: 1400: 0-400-600-800-1000-1200-1400

Delay

Delay

1. Select a programme
2. Press the Delay button to choose the delaying time 0-24h
3. Press [Start/Pause] to start the delay operation



Choose programme

Setting time

Start

To cancel the Delay function, press the "Delay" button before starting the program until the display shows 0 h. If the program has already started, switch the appliance off and afterwards on and select a new programme.



Mute the buzzer



Choose the Programme

Press the [Speed] button for 3sec.,
the buzzer is mute.

To act the buzzer function, press the button again for 3 seconds. The setting will be kept until the next reset.

Caution!

- After Muting the buzzer function, the sounds will not be activated any more.

OPERATION



Dry Level

Press the Dry button continuously to choose the dry level: Soft Dry/Extra Dry/ Normal Dry/ Timer Dry.

- ☀ Soft Dry: Only to dry slightly and then is just ok;
- ☀ Extra Dry: Need to wear clothes immediately ,we can choose this function
- ☀ Normal Dry: The normal dry procedure
- ☀ Timer Dry: We can choose this function to dry clothes for a specific time.

Note!

- Drying hints
 - Clothes could be dried after spinning
 - To ensure quality dry the textiles, please classify them according to their kinds and the drying level.
 - Synthetic should be set the proper drying time (use dry function to select proper drying time) .
 - If you want to iron the clothes after drying, please put them for a while.
- Clothes not suitable for drying
 - Particularly delicate items such as synthetic curtains, woolen and silk, clothes with metal inserts, nylon stockings, bulky clothes, such as anoraks, bedcovers, quilts, sleeping bags and duvets must not be dried.
 - Clothes padded with foam-rubber or materials similar to foam-rubber must not be machine dried.
 - Fabrics containing residues of setting lotions or hair sprays, nail solvents or similar solutions must not be machine dried in order to avoid the formation of harmful vapours.

OPERATION



Child Lock

This function is meant to keep children from misusing the controls.

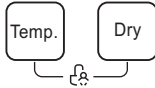

Press [Temp.] and [Dry] simultaneously for 3 sec until the buzzer beep. The child lock indicator switches on.



Caution!

When the Child Lock is activated, the display will alternately show "CL" and the remaining time.

Pressing any other button will cause the Child Lock indicator to flash.

When the program ends, "CL" and "END" will alternate on the display.

The Child Lock deactivates the function of all buttons except the Child lock button! Only the simultaneous pressing of the two buttons [Temp.] and [Dry] can deactivate the Child Lock!

Please deactivate the Child Lock before selecting a new program!



Drum Clean

After the machine runs to the set counting period(counting cycle is 25 times), Drum Clean lamp flashes at the end of the last program, reminding the user to run the program;

Release condition:

1. Press and hold the Drum Clean button for 3s, Drum cleaner indicator remind will be cancel and the washing cycles will be recount for another 25 cycles.
2. The counted cycles will be recounted when drum clean program is finished.

MAINTENANCE

■ Cleaning and Care

⚠ Warning!

- Always unplug the appliance and close the water tap before cleaning and maintenance.

Cleaning the Cabinet

Proper maintenance on the washing machine can extend its working life. The surface can be cleaned with diluted non-abrasive neutral detergents when necessary. If there is any water overflow, use a cloth to wipe it off immediately. Never use sharp items to clean the appliance.

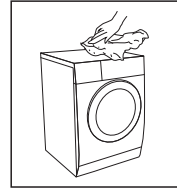

⚠ Caution!

- Never use abrasive or caustic agents, formic acids or its diluted solvents or similar substances, like alcohol or chemical products.

Cleaning the Drum

Any rust stains left inside the drum by metal articles must be removed immediately using chlorine-free detergents. Never use steel wool for cleaning the drum!

📌 Note!

- Keep any laundry away from the machine while cleaning the drum.

Cleaning the Door Seal and Glass

Wipe the glass and seal after each wash to remove lint and stains. If lint builds up it can cause leakages. Remove any coins, buttons and other objects from the seal after each wash. Clean the Door Seal and Glass every month to ensure the normal operation of the appliance.

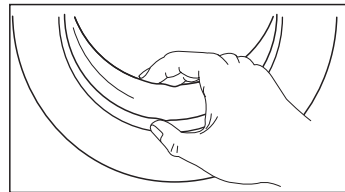

MAINTENANCE

Cleaning the Inlet Filter

Note!

- Diminishing water flow is a sign that the filter need to be cleaned.

1. Close the tap and remove the water supply hose from it.
2. Clean the filter with a brush.
3. Unscrew the water supply hose from the backside of the machine. Pull out the filter with long nose pliers.
4. Use a brush to clean the filter.
5. Reinstall the filter to the water inlet and reconnect the water supply hose.
6. Clean the Inlet filter every 3 months to ensure the normal operation of the appliance.

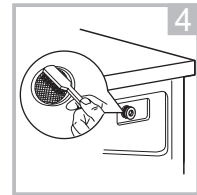
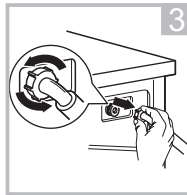
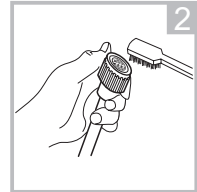
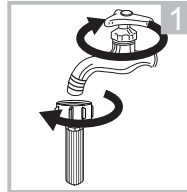

Clean The Detergent Dispenser

1. Press down the release [] on the softener cover and pull the dispenser drawer out of the recess. Clean the inside of the recess with a brush.
2. Lift the softener cover off the dispenser drawer and wash both items with water.
3. Restore the softener cover and push the drawer back into the recess.

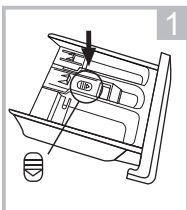

Press the release and remove the dispenser drawer

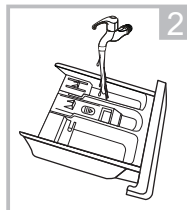

Clean the dispenser drawer and the softener cover under water

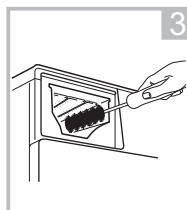

Clean the recess with an soft brush

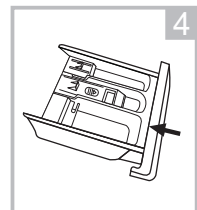

Insert the dispenser drawer

Note!

- Do not use abrasive or caustic agents to clean plastic parts.
- Clean the detergent dispenser every 3 months to ensure the normal operation of the appliance

MAINTENANCE

Cleaning the Drain Pump Filter

⚠ Warning!

- Make sure that the machine has finished the washing cycle and is empty. Switch it off and unplug it before cleaning the drain pump filter.
- Be careful of hot water. Allow the water to cool down. Risk of scalding!
- Clean the filter periodically every 3 months to ensure the normal operation of the appliance.

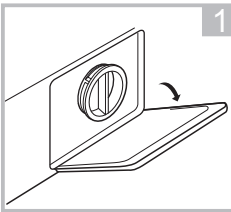

Open the lower cover cap

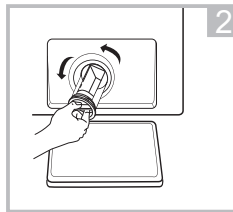

Open the filter by turning to the counter clockwise

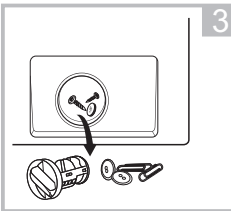

Remove extraneous matter

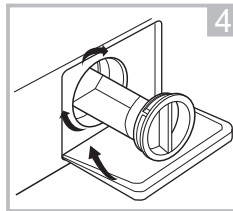

Close the lower cover cap

⚠ Caution!

- When the appliance is in use and depending on the programme selected there can be hot water in the pump. Never remove the pump cover during a wash cycle, always wait until the appliance has finished the cycle, and is empty. When replacing the cover, ensure it is securely re-tightened.

MAINTENANCE

■ Trouble Shooting

Whenever there is a problem with the appliance, check if you can solve it following the tables below. If the problem persists, please contact the customer service.

Description	Possible cause	Solution
Appliance does not start	Door is not closed properly. Clothes are stuck.	Close the door properly and restart. Check the laundry.
Door can't be opened	Safety protection is activated.	Disconnect the power and restart.
Water leakage	Connections are not tight enough.	Check and fasten the water inlet pipe. Check and clean the outlet hose.
Detergent residues in the detergent dispenser	Detergent is damp and/or clotted.	Clean and wipe the detergent dispenser dry.
Indicator or display does not work	PC board or harness have connection problems.	Switch off the power and check if the mains plug is connected properly.
Abnormal noise	Fixing bolts still in place. Floor is not solid or level.	Check if the fixing bolts have been removed Make sure the appliance is installed on a solid and level floor.

Error Codes

Description	Possible cause	Solution
E30	Door is not closed properly	Close the door properly and restart.
E10	Water injecting problem during wash cycle.	Check if the water pressure is high enough. Straighten the water pipe. Clean the inlet valve filter.
E21	Overtime water draining	Check the drain hose for blockage.
E12	Water overflow	Restart the appliance.
EXX	Others	Restart the appliance. If problem persists, please contact the customer service.

MAINTENANCE

Customer service

Spare part for your appliance are available for a minimum of 10 years.

In case of questions please contact our customer service at:

Warning!

Risk of electric shock

- Never try repair an appliance which is defective or presumed to be defective. You may put your own and future users' lives in danger. Only authorised specialists are allowed to carry out this repair work.
- Improper repair will void the warranty and subsequent damages can't be recognized!

Transport

IMPORTANT STEPS WHEN MOVING THE APPLIANCE

- Unplug the appliance and close the water inlet tap.
- Check, if the door and the detergent dispenser are closed properly.
- Remove the water inlet pipe and the outlet hose from the house installations.
- Let the water drain completely from the appliance (see "Maintenance Cleaning the drain pump filter")
- Important: Re-install the 4 transport bolts in the back of the appliance.
- This appliance is heavy. Transport with care. Never hold any protruding part of the machine when lifting. The machine door cannot be used as a handle.

Technical Specifications

Power Supply	220-240V~,50Hz
--------------	----------------

MAX.Current	10A
-------------	-----

Standard Water Pressure	0.05MPa~1MPa
-------------------------	--------------

Model	ED-WDC74WH
-------	------------

Washing Capacity	7.0kg
------------------	-------

Drying Capacity	4.0kg
-----------------	-------

Dimension(W*D*H)	595*565*850
------------------	-------------

Weight	74kg
--------	------

Rated Power	2050W
-------------	-------

Drying Power	1350W
--------------	-------

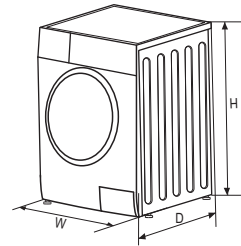

MAINTENANCES

■ Testing methods

Model:ED-WDC74WH

ADDITIONAL INFORMATION FOR Standard performance TESTING:
(AS/NZS 2040.1:2005+Amdt1-2007+Amdt2-2009)

1. Water connections: Cold & hot water connection
2. Water supply pressure: 320 kPa
3. Warm wash Program: Cotton Eco, 60°C, Speed 1400rpm, Display: 6:04
Cold wash program: Cotton Cold(no temperature display is cold wash)
4. Detergent type: Drum detergent
5. Detergent quantity: Default
6. Adding detergent:
The detergent is dissolved and added as Paragraph B7.3 of AS/NZS 2040.1
The detergent shall be dissolved in 1 L of water
7. Anti-sudsing agent: Max
8. Test load mass: 7.0kg
9. Water consumption: 71L
10. Test Voltage: 220-240V~, 50Hz

